

Silicon Carbide Schottky Diode

QSD-HCS020X120

Features

- 1200v schottky rectifier
- Zero reverse recovery current
- High-frequency operation
- Temperature-independent switching behavior
- Extremely fast switching

V _{rrm} =	1200 V
I _f (T _c =155 °C)	20 A
Q _c =	107 nC

Benefits

- Replace bipolar with unipolar rectifiers
- Essentially no switching losses
- Higher efficiency
- Reduction of heat sink requirements
- Parallel devices without thermal runaway

Package



Applications

- Switch mode power supplies (SMPS)
- Power factor correction
- Motor drives

Part Number	Package	Marking
QSD-HCS020X120	Die Only	Q

Silicon Carbide Schottky Diode

QSD-HCS020X120

Maximum Rated Values (Tc=25°C unless otherwise specified)

Symbol	Parameter	Value	Unit	Test Conditions	Note
Vrrm	Repetitive Peak Reverse Voltage	1200	V		
If	Continuous Forward Current	67	A	Tc=25°C	Fig.3
		32		Tc=135°C	
		20		Tc=155°C	
Ifrm	Repetitive Peak Forward Surge Current	119	A	Tc=25°C, Tp=10ms, Half Sine Pulse	
		78		Tc=110°C, Tp=10ms, Half Sine Pulse	
Ifsm	Non-Repetitive Forward Surge Current	140	A	Tc=25°C, Tp=10ms, Half Sine Pulse	
		120		Tc=110°C, Tp=10ms, Half Sine Pulse	
Ptot	Power Dissipation	319	W	Tc=25°C	Fig.4
		138		Tc=110°C	
Tj	Operating Temperature	-55 to +175	°C		
Tstg	Storage Temperature	-55 to +175	°C		

Electrical Characteristics (Tj=25°C)

Symbol	Parameter	Value			Unit	Test Conditions	Note
		Min.	Typ.	Max.			
Vf	Forward Voltage		1.4	1.9	V	If=20A, Tj=25°C	Fig.1
			1.9			If=20A, Tj=175°C	
Ir	Reverse Current		10	200	µA	Vr=1200V, Tj=25°C	Fig.2
			147			Vr=1200V, Tj=175°C	
Qc	Total Capacitive Charge		107		nC	Vr=800V, Tj=25°C	Fig.5
C	Total Capacitance		1615		pF	Vr=0V, Tj=25°C, f=1MHz	Fig.6
			94			Vr=400V, Tj=25°C, f=1MHz	
			88			Vr=800V, Tj=25°C, f=1MHz	
Ec	Capacitance Stored Energy		27		µJ	Vr=800V	Fig.7

Thermal Characteristics

Symbol	Parameter	Value	Unit	Note
Rθjc	Thermal Resistance (Junction to Case)	0.47	°C/W	Fig.8

Typical Performance

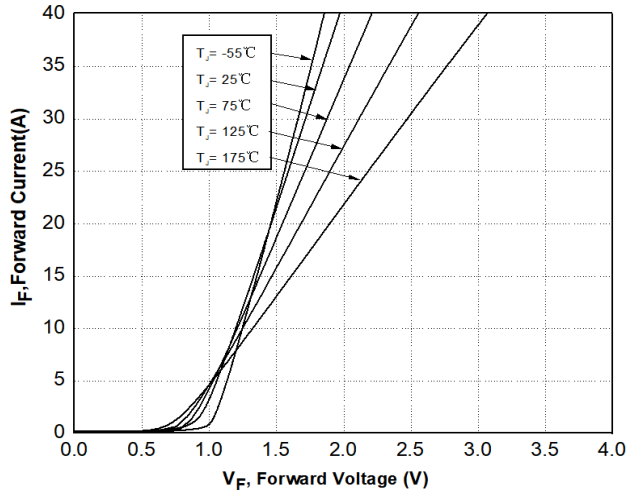

Figure 1. Forward Characteristics

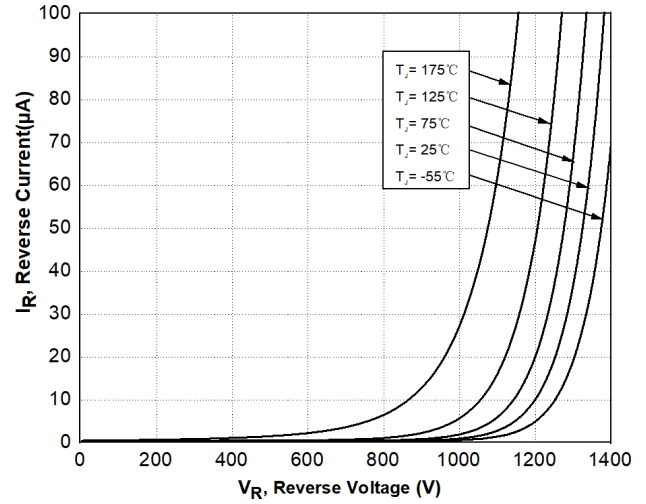

Figure 2. Reverse Characteristics

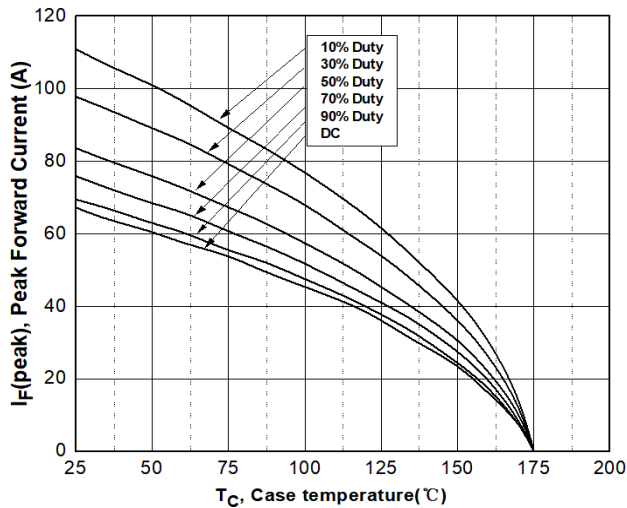

Figure 3. Current Derating

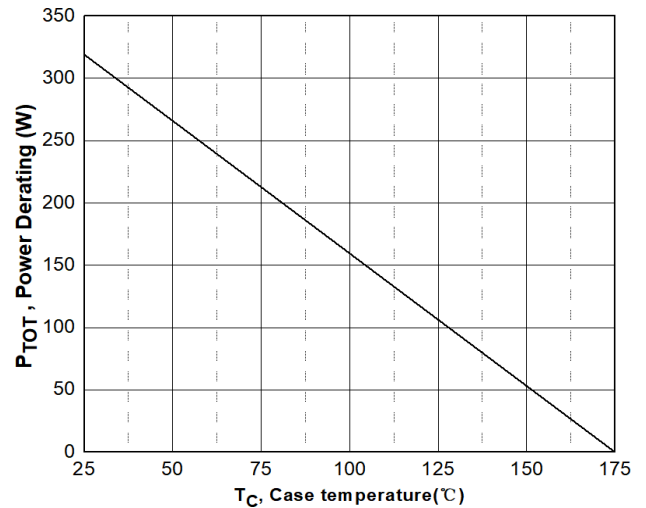

Figure 4. Power Derating

Typical Performance

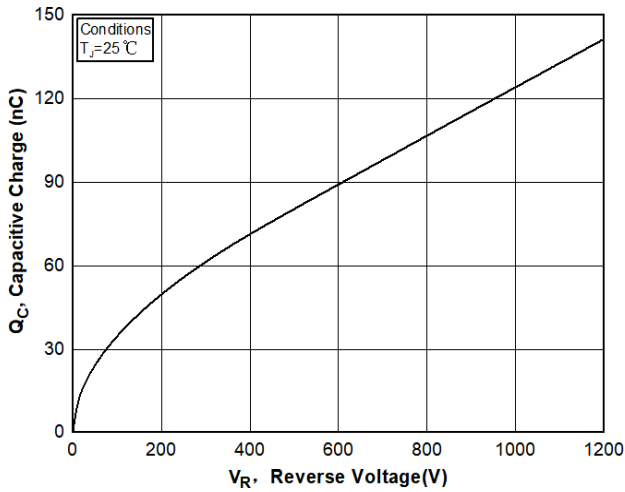

Figure 5. Capacitance Charge Vs. Reverse Voltage

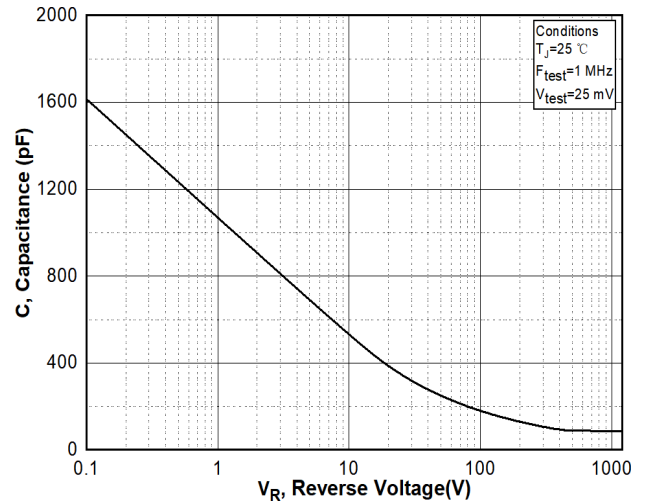

Figure 6. Capacitance Vs. Reverse Voltage

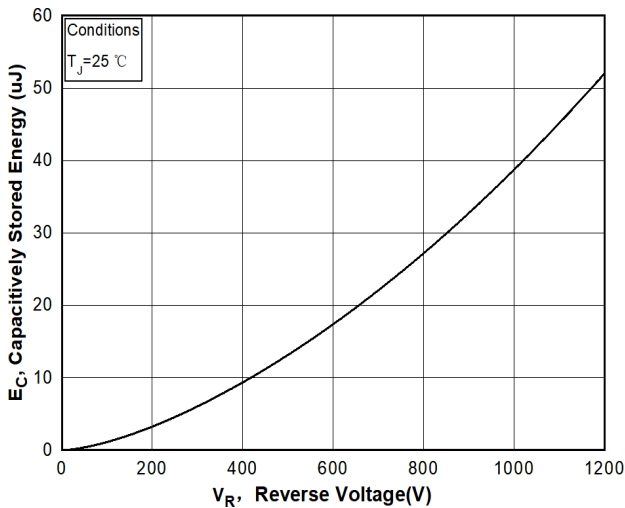

Figure 7. Capacitance Stored Energy

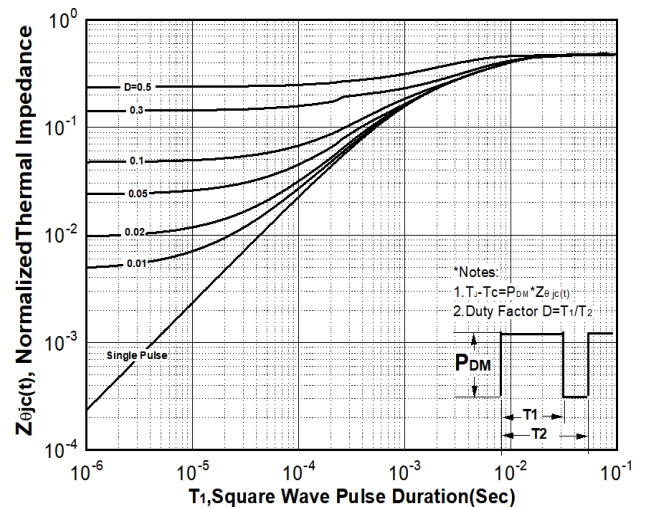
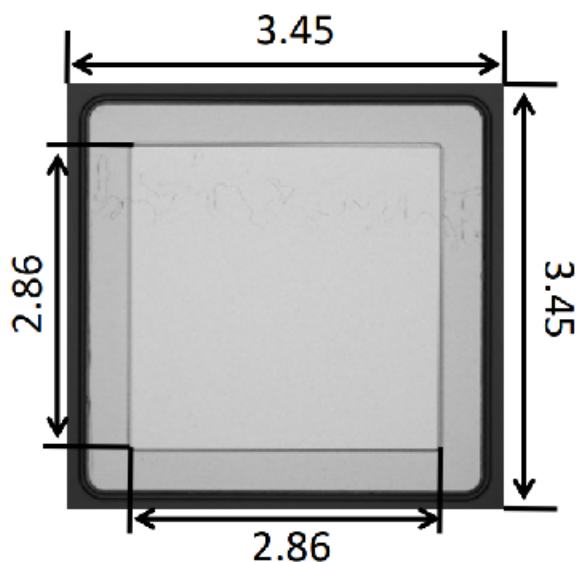

Figure 8. Transient Thermal Response Curve(Junction-to-Case)

Package Dimensions



Product Dimensions

Parameter	Typical	Units
Die Size (LxW)	3.45x3.45	mm
Anode Pad Opening	2.86x2.86	mm
Die Thickness ¹	364±10%	μm
Top side Anode Metalization (Al)	4	μm
Back side Cathode Metalization (Ti/Ni/Ag)	2.05	μm
Front side Passivation (polymide)	SiO ₂ Polyimide	

Attention

- Specifications of any and all products described or contained herein stipulate the performance, characteristics, and functions of the described products in the independent state, and are not guarantees of the performance, characteristics, and functions of the described products as mounted in the customer's products or equipment. To verify symptoms and states that cannot be evaluated in an independent device, the customer should always evaluate and test devices mounted in the customer's products or equipment.
- We assume no responsibility for equipment failures that result from using products at values that exceed, even momentarily, rated values (such as maximum ratings, operating condition ranges, or other parameters) listed in products specifications of any and all Silicon products described or contained herein.
- Any and all information described or contained herein are subject to change without notice due to product/technology improvement, etc.